

# SRS A2/M2

## user manual



**DESERTTECH**  
TOMORROWS WEAPONS

# STERAL TIT SRR-70 RECOR SCOUT





# TABLE OF CONTENT

SAFETY.....	4
WARNINGS.....	4
DT & SRS PRESENTATION.....	5
BOX CONTENT.....	6
GUN DESCRIPTION.....	6
BOLT ASSEMBLY.....	7
SAFETY.....	8
MAGAZINE.....	8
SHOOTING.....	9
HOPUP ADJUSTMENT.....	10
ADVANCED SETTINGS & ERGONOMICS.....	11
TRIGGER BOX ADJUSTMENTS.....	11
CHEEKPAD ADJUSTMENTS.....	11
BUTTPLATE ADJUSTMENTS.....	11
BARREL SWAP.....	11
MAGAZINE FOLLOWER SWAP.....	11
EXPLODED VIEWS.....	12
MATERIALS.....	13
SIZE/MASS.....	13
SERIAL NUMBER.....	14
NOTES.....	14

TRIGGER BOX  
REAR  
S

MM

REAR

MM

REAR

# SAFETY

**READ THIS MANUAL CAREFULLY AND THOROUGHLY BEFORE USE**, users should obey to laws regarding the usage and ownership of airsoft guns in their country. Misuse or careless use may cause serious injuries. Always treat airsoft guns as if they are loaded and with the same respect as you would treat firearms. Do not look into an airsoft gun muzzle. Never point the airsoft gun at something you do not intend to shoot. Users should always wear safety glasses. Always carry the airsoft gun in a bag or a case and never display it in public places. Always keep the airsoft gun in "safe" mode until you are ready to shoot at a safe direction. Always check that the airsoft gun is in "safe" mode and unloaded when getting it from another person or from storage. Do not put the airsoft gun away or in storage while it is still loaded. Do not shoot at hard surfaces or water surfaces as bbs could bounce or ricochet and hit someone or something you do not intend to hit. Always use high quality 6mm plastic bbs and never use already shot bbs as it may damage your airsoft gun. Always store airsoft guns in a secure place and out of reach from children. Do not attempt to modify or alter your airsoft guns, as doing so may make you airsoft gun unsafe to use and/or cause serious injuries and/or void the warranty. **WE ARE NOT RESPONSIBLE FOR ANY MALFUNCTION, ACCIDENTS, INJURIES OR REPAIR COST RESULTING FROM MISUSE, DISASSEMBLY AND/OR MODIFICATION OF THIS AIRSOFT GUN.**



## WARNINGS

- Take care of the feeding tube during barrel swaps to avoid damaging it.
- Do not loosen the 4 barrel screws too much while changing the barrel or you will damage the right stock panel.
- Do not overtighten the hopup screws or you will damage the hopup rubber.
- In case of inner barrel disassembly, do not overtighten the lateral screws or you will damage the inner barrel.
- Do not prime the bolt while the safety is engaged or you will damage the trigger rod.
- Do not pull the trigger while the bolt is not locked or you will damage the receiver.
- Using the trigger preload at maximum will generate safety problems and probably slam-fire problems.
- Do not overload the magazine or you will damage the magazine spring.
- Do not blank fire without barrel assembly or you will damage the gun.
- Do not fire if the barrel is not properly secured. We recommend 4 Nm torque on the four M6X16 screws.
- For storage, keep the steel parts greasy to avoid rusting.
- Do not use the gun without greasing the outside of the bolt (except the nozzle).
- Do not apply any grease/oil inside the hopup and/or the barrel.
- If you are using long knurled hopup screws, you have to remove them before attempting a barrel swap.
- Keep the bolt closed during barrel changes to ensure perfect bolt/barrel alignment.
- Make sure no bbs remain in the hopup and the feeding tube before removing the barrel.
- Removing/grinding the bolt lug will reduce your rifle's accuracy and damage the receiver.
- By construction, the handguard is not precisely coaxial with the receiver, therefore the barrel could be off-centered in the handguard while being centered in the receiver.
- Using a "centering spacer" between the handguard and the barrel can potentially flex the barrel, negate the floating barrel effect, and reduce the accuracy of the rifle.





# DESERT TECH<sup>®</sup>

## ▶ TOMORROWS WEAPONS ▶

Desert Tech, formerly Desert Tactical Arms, has been building a better rifle since 2007 when we realized the demands of future battlefields exceeded the capabilities of current platforms. We decided then to build our rifles more accurate, more compact, more convertible for an increasingly complex world.

Our R&D department is tasked daily to fuse ground-breaking engineering with American ingenuity so that skilled machinists on state-of-the-art mills and lathes can shape battle-tested materials into Tomorrow's Weapons. Each Desert Tech rifle that enters our network of nationwide dealers and international distributors is both ergonomically and ballistically superior to any other production rifle on the planet.

Desert Tech also offers select, premium, match-grade munitions as well as world-class precision instruction across the 25,000 acres of natural terrain and sophisticated training bays at our private facility. These features compliment a complete package of detail-driven customer service for the modern-day warrior, hunter or competition shooter who demands peak performance with each and every trigger press of a Desert Tech SRS, Covert, HTI or MDR.

From concept to recoil, we are creating uncommon and uncompromising firearms with the sole intent of arming serious shooters to the very edge of their abilities and beyond. At Desert Tech, we're building Tomorrow's Weapons and it begins with a better rifle today.

The Stealth Recon Scout A2 (SRS-A2) is the most versatile Sniper Rifle system in the world. It is nearly a foot shorter than conventional sniper rifles, maintains 1/2 MOA or better accuracy with DTM Ammunition, and can be easily adapted to individual mission requirements by changing the weapon's caliber and length. Whether a police sniper is shooting 50 yards or a military sniper is shooting a mile the SRS offers unrivaled flexibility in a package shorter than the M16 battle rifle.

### Accuracy

The SRS achieves superb accuracy in all calibers because it's built around core accuracy components:

1. Match grade (free-floated) barrels, chambers, and crowns
2. High quality match trigger
3. Solid, repeating return-to-zero barrel mounting system (the receiver securely clamps around the first six inches of barrel)

### Quick Caliber Conversion

The SRS is quickly convertible between the following calibers: .308 Winchester (22" and 26" barrels), .260 Remington, 6.5x47 Lapua, 6.5 Creedmoor, 7mm Winchester Short Mag, .300 Winchester Magnum, .338 Norma Magnum, and .338 Lapua Magnum. The caliber conversion and return to zero is simple and takes less than 60 seconds.

Benefits:

1. Operators can change rifle length, penetration, and distance capabilities.
2. Snipers can shoot various ammo calibers and types depending on METT-T.
3. Snipers can progressively train on more powerful ammo.
4. Reduced training costs (train and practice with .308 WIN)
5. Reduced system down-times (the operator can change his own barrels).

### Compact

The SRS is the shortest purpose-built sniper rifle in the world. The telescoping bolt and bullpup configuration make it almost a foot shorter than conventional Mauser-style turnbolt sniper rifles. The compact design shifts weight and center-of-gravity rearward, creating a perfectly balanced and relatively short sniper rifle.

### Rugged

The SRS was designed to operate under the harshest conditions and abuse. It is built of high-impact polymers; aircraft grade aluminum (ANSI 7075-T6); ultra high-strength steels; and some of the most durable coatings known to man. The monolithic receiver serves as a full length mounting chassis, eliminating the need for any sort of receiver-to-stock bedding interface. Ergonomic stock panels attach directly to the receiver.

The SRS maintains its accuracy and reliability in virtually any environment, including subzero arctic temperatures, extreme desert heat and dust, and wet jungle environments.

*Nicholas E Young*





# BOX CONTENT

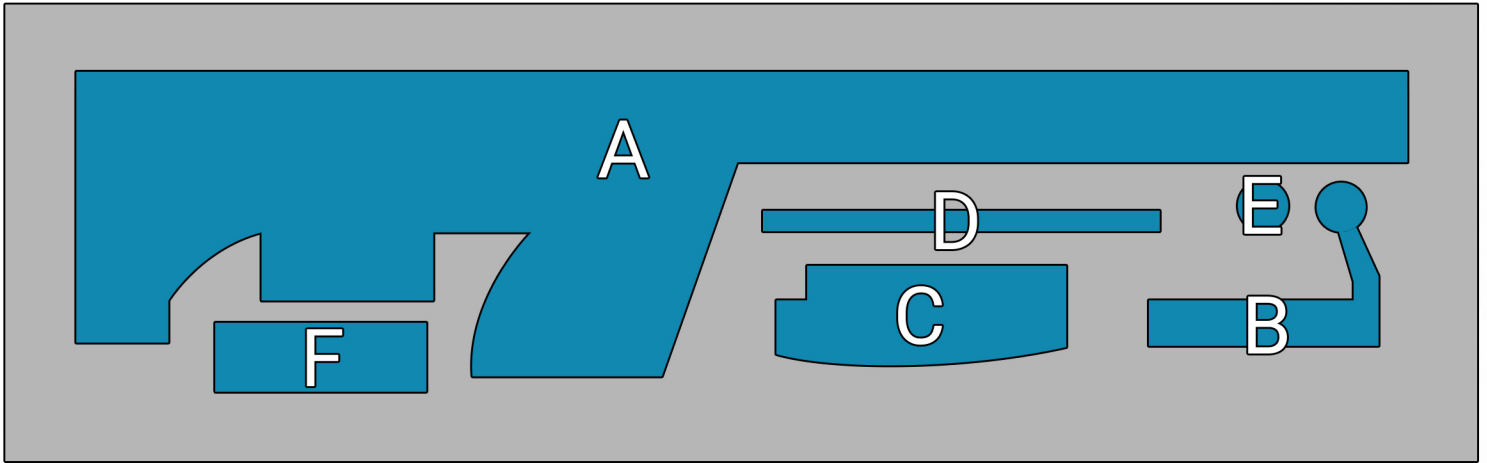

- A: Rifle with magazine engaged
- B: Bolt
- C: Buttplate
- D: Spring
- E: Grease pot
- F: Accessories bags, dustcover

# GUN DESCRIPTION

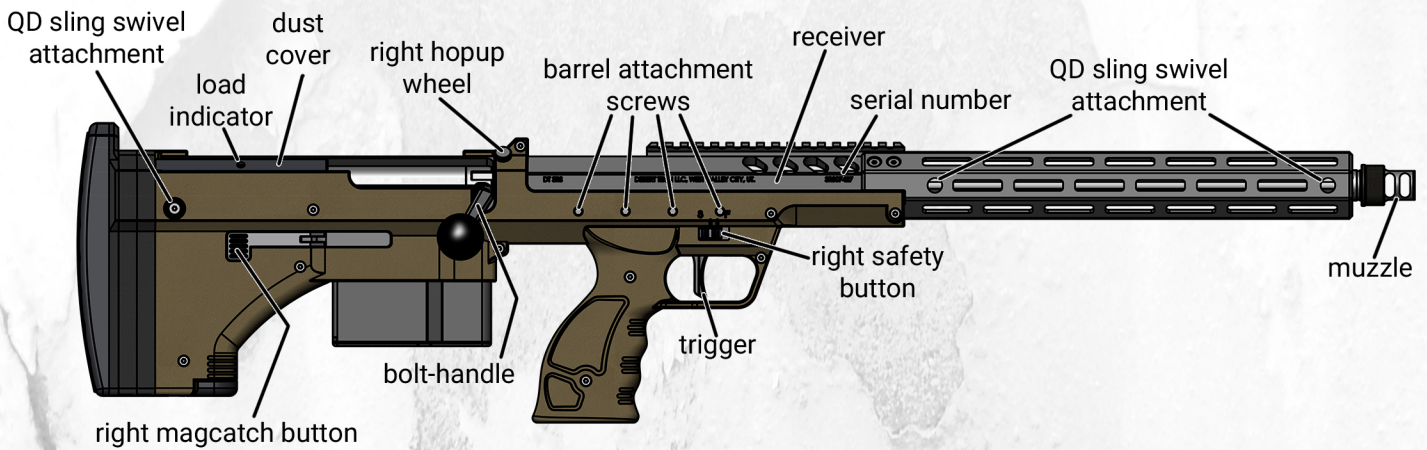



# BOLT ASSEMBLY

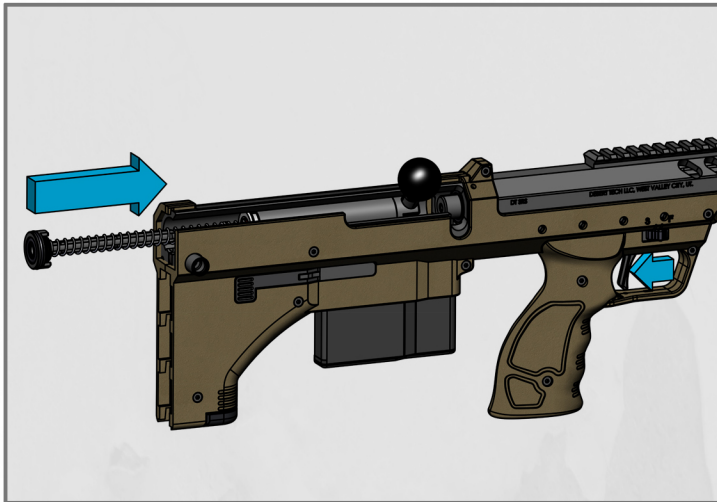

While pulling the trigger, insert the bolt, the piston and the spring guide inside the receiver.

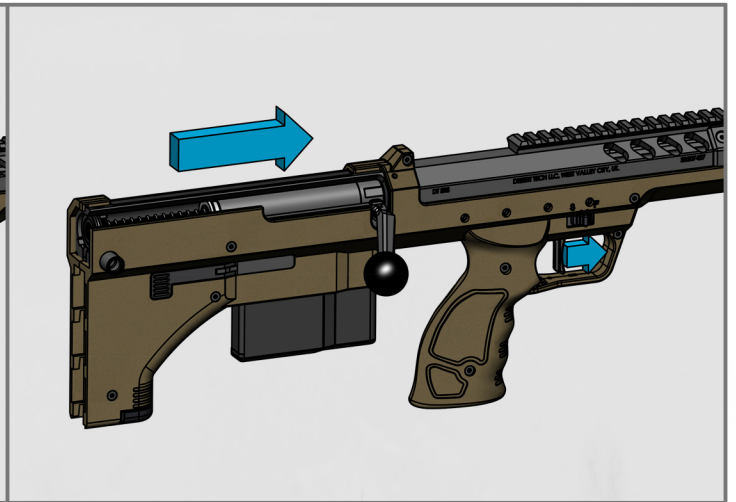

Compress the spring and engage the spring guide behind the piston sear. Push forward the trigger to lock the spring guide in position.

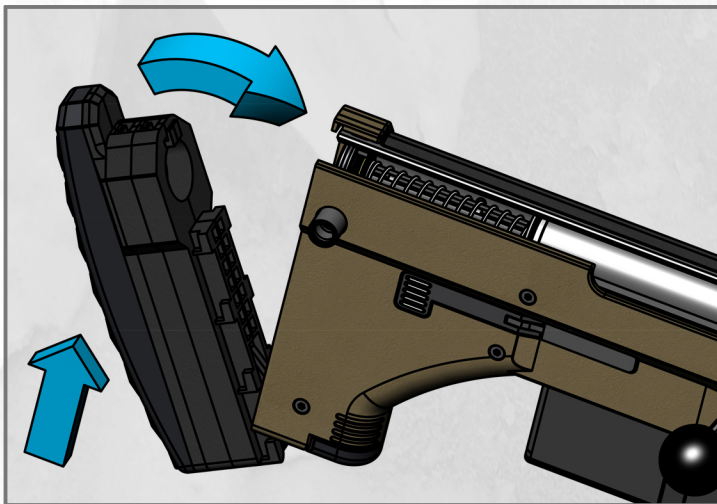

Engage the buttplate by the bottom side and slide it upward.

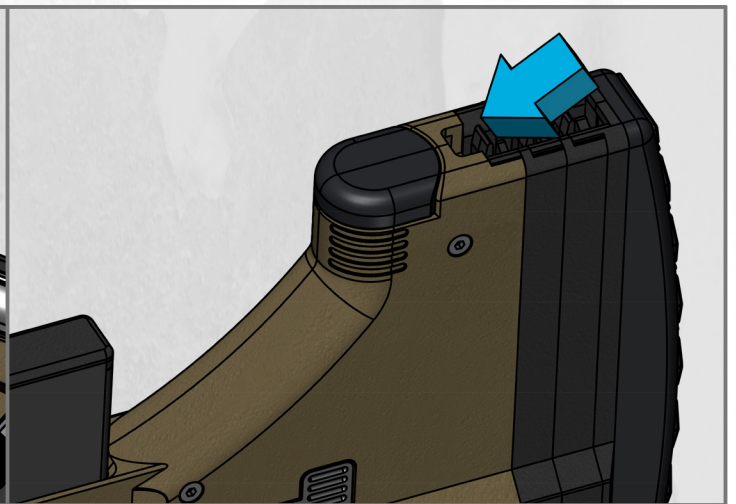

Push forward the tab until it clicks to lock the buttplate in position.

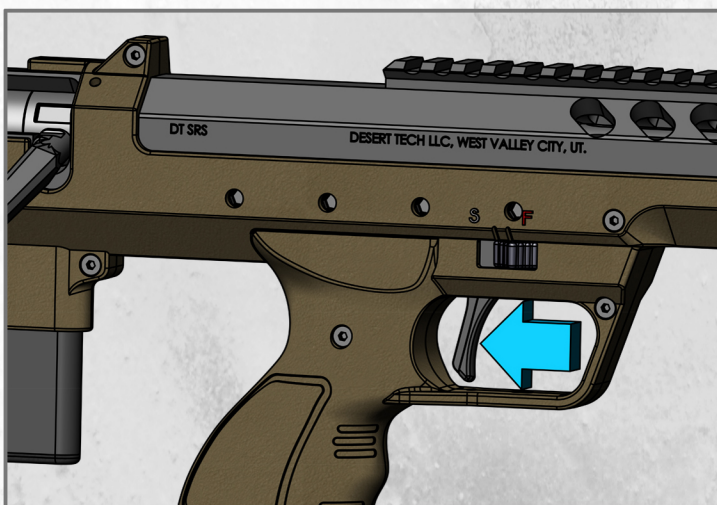

Pull the trigger to release the spring guide in the buttplate. Make sure the spring guide is sitting in the correct position.

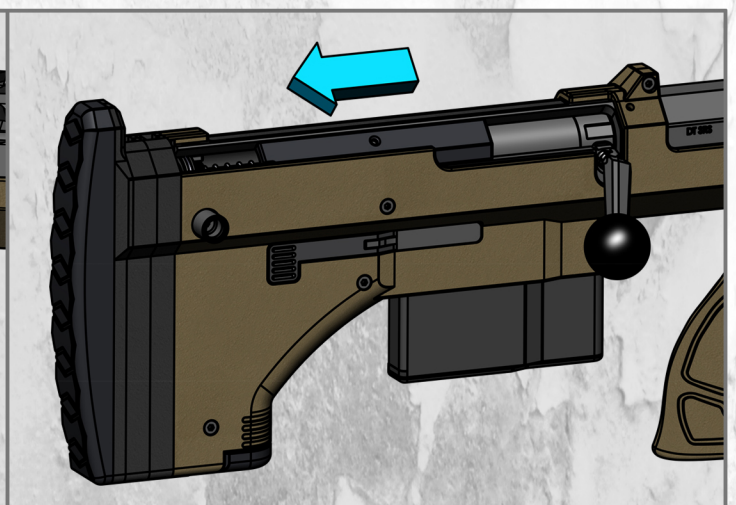

Insert the dust cover into the ejection window, then slide it backward. Use the bolt handle to ease the installation.



# SAFETY

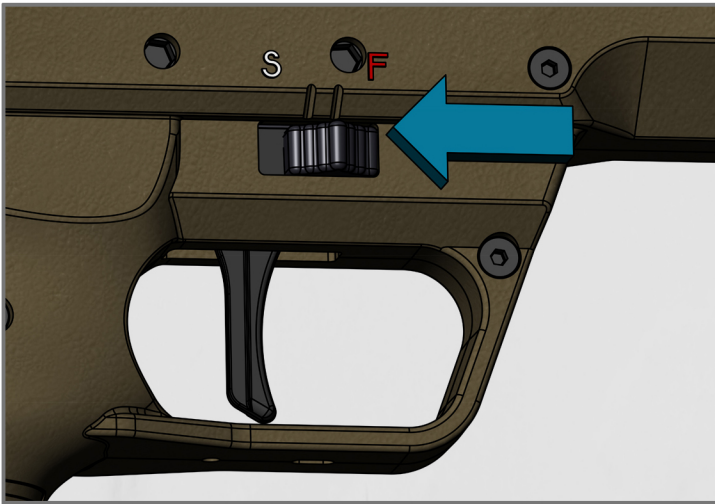

Slide the safety button (left or right) to «S» position to engage the safety.

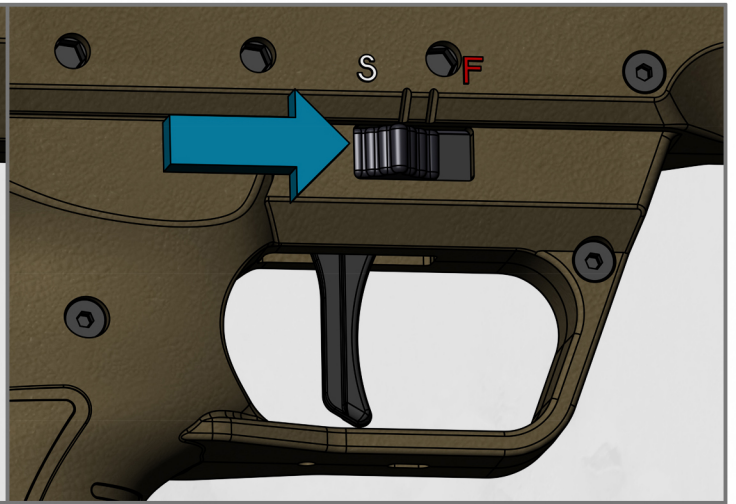

Slide the safety button (right or left) to «F» position to disengage the safety.

# MAGAZINE

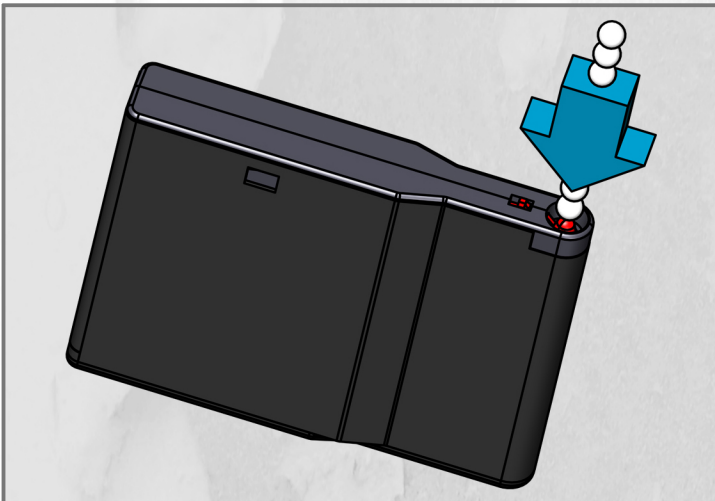

Fill the magazine with 6 mm bbs (by hand or by a bb-loader).

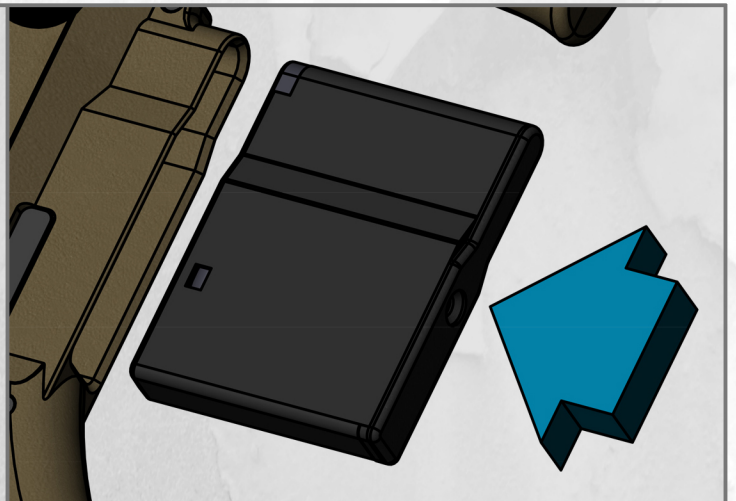

Insert firmly the magazine inside the magwell until the magcatch locks it in place.

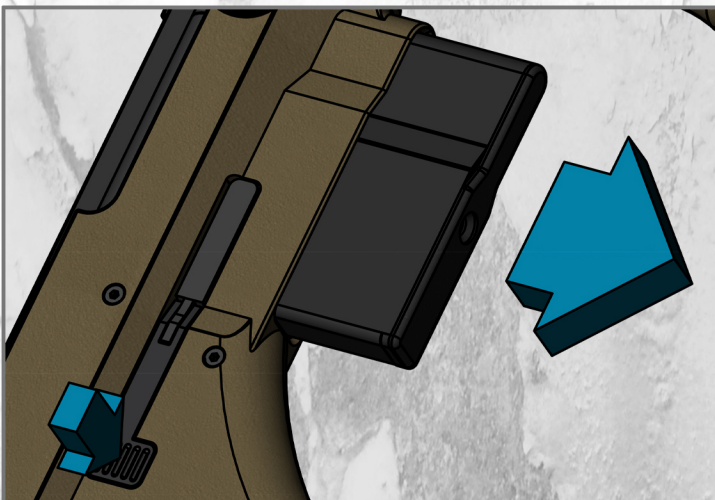

To remove the magazine, press the magcatch button and pull down the magazine.

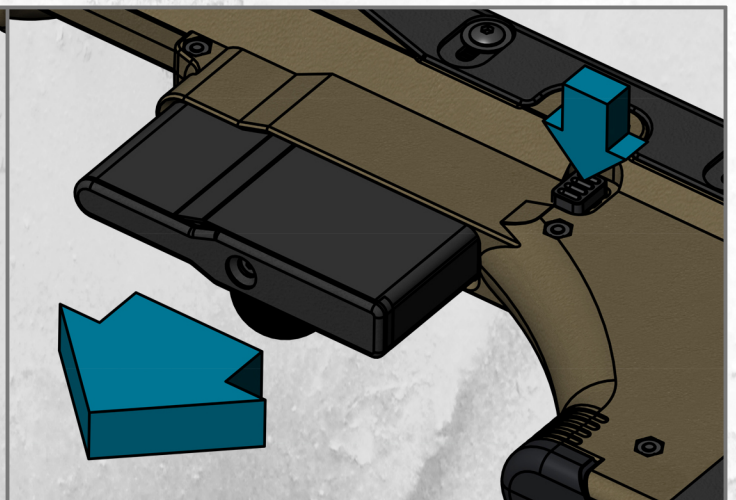

You can also remove the magazine using the left side magcatch button.



# SHOOTING

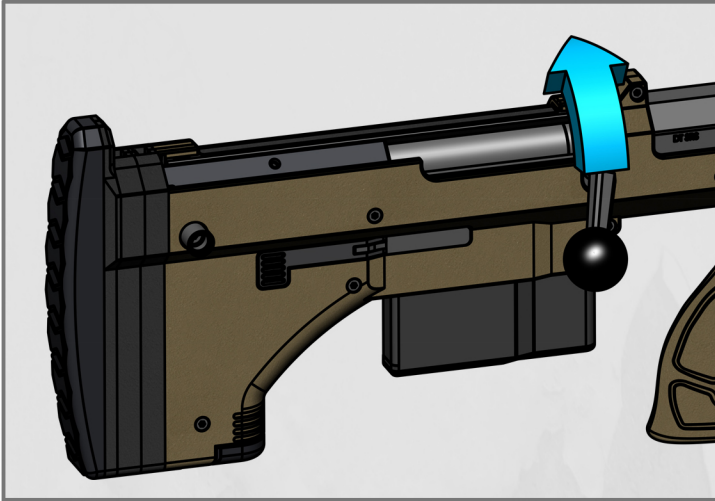

Lift up the bolt handle (make sure the bolt is not already armed to avoid double feeding).

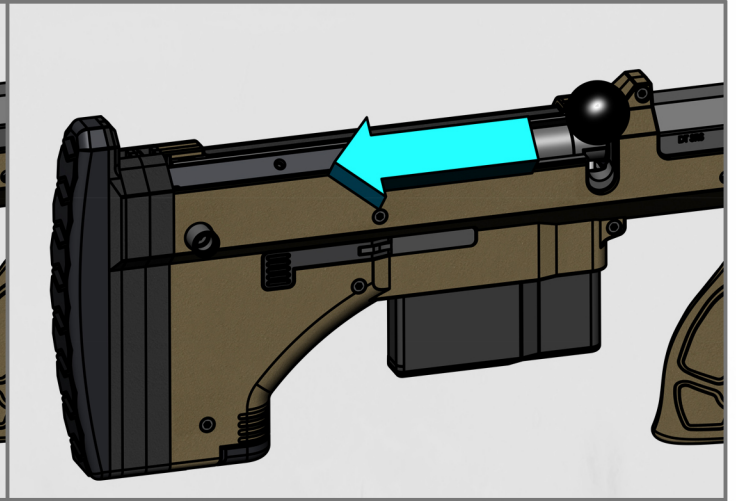

Move the bolt backward to compress the spring and lock the piston sear (until it clicks).



It is recommended that you pull the bolt by grabbing the bolt handle as close to the cylinder as possible to reduce friction and ease the priming movement.

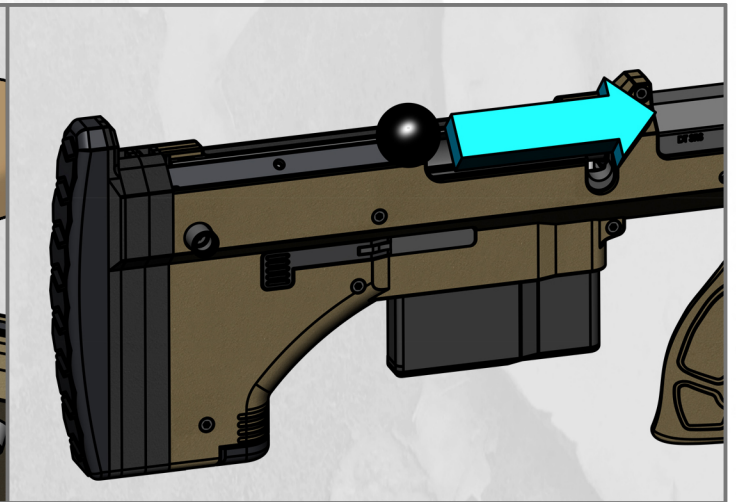

Push the bolt forward to engage a bb inside the hopup (you can visually check inside the hopup if the magazine is empty).

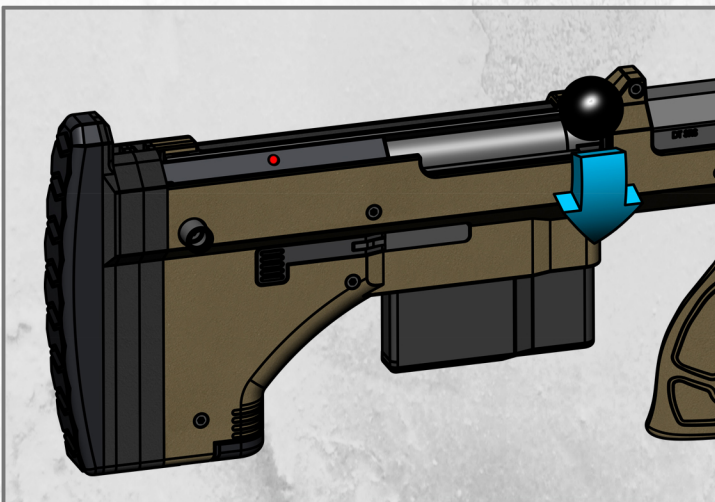

Lock down the bolt handle to lock the bolt. You can check the priming indicator : it should be now in red color, indicating the gun is ready to fire. This feature isn't available for lefty SRS.



Pull the trigger to shoot. Be sure that the safety is off. Do not shoot without the barrel assembly installed or else it will damage the mechanism.



# HOPUP ADJUSTMENT

The hopup can be adjusted with thumb screws or with set screws (M3X4 ISO 4026, please check the accessories bag included with this airsoft replica). Thumb screws allow toolless adjustments, and set screws allow barrel swaps without affecting your hopup adjustments. Up to you to choose depending on your personal preferences.

Out of the box, your SRS is assembled with 3X2 dampening o-rings under the hopup adjustment screws. If you need more adjustment range, replace these o-rings by 3x1.5 o-rings (included in the accessories bag).

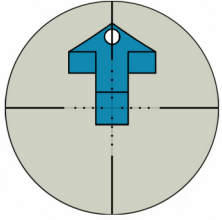

Case #1: too much hopup effect without side spin: loosen both hopup screws equally.

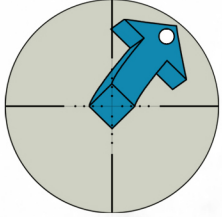

Case #2: too much hopup effect with right side-spin: loosen the right side hopup screw.

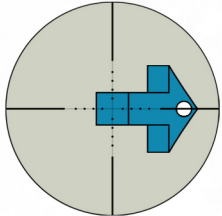

Case #3: good hopup effect with right side-spin: loosen the right side hopup screw and tighten the left side hopup screw.

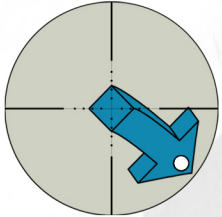

Case #4: not enough hopup effect with right side-spin: tighten the left side hopup screw.

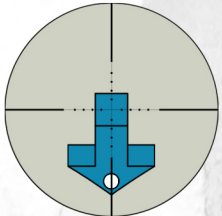

Case #5: not enough hopup effect without side-spin: tighten both hopup screws equally.

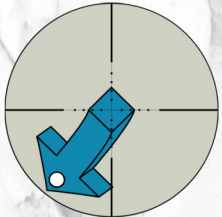

Case #6: not enough hopup effect with left side-spin: tighten the right side hopup screw.

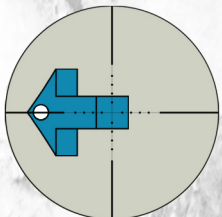

Case #7: good hopup effect with left side-spin: tighten the right side hopup screw and loosen the left side hopup screw.

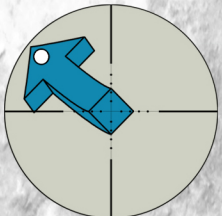

Case #8: too much hopup effect with left side-spin: loosen the left side hopup screw.

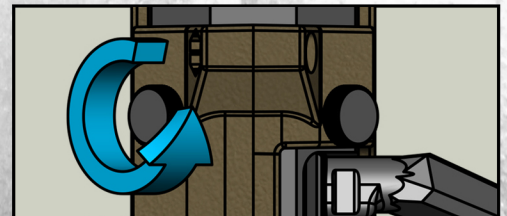
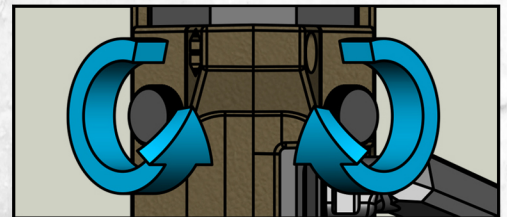
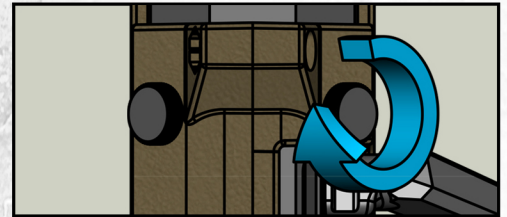
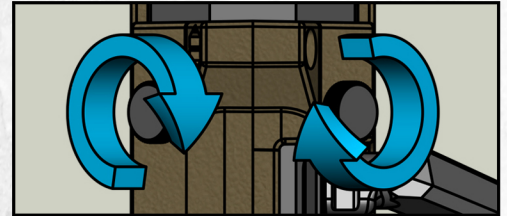
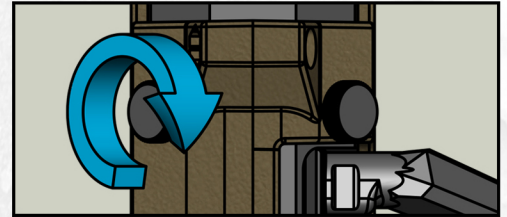
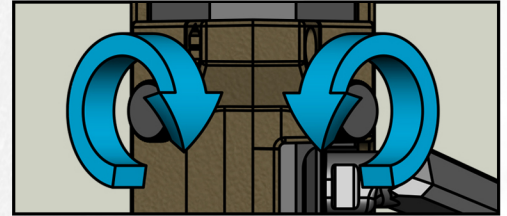



# ADVANCED SETTINGS & ERGONOMICS

To help you for these ergonomic and advance settings, you can check out our YouTube channel where you can find many video tutorials. Scan this QR code to access our Youtube page.

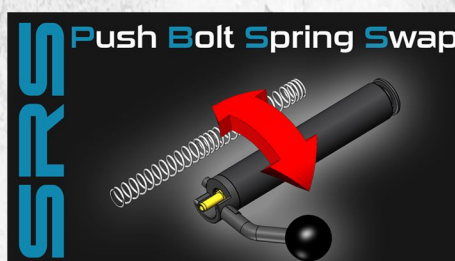
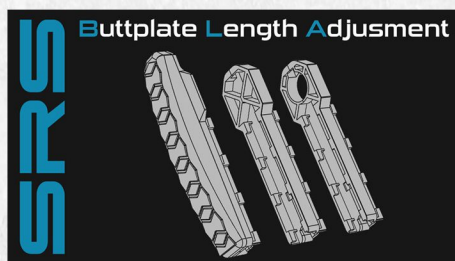
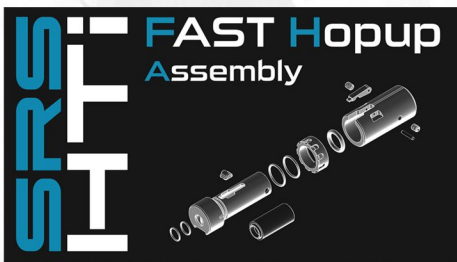

# EXPLODED VIEWS

Scan this QR code to access detailed exploded views for all SRS-A2 versions (right handed, left handed, 22" barrel, 16" barrel, sport barrel), and the parts nomenclature.





# MATERIALS

	Receiver	STD. Handguard	Sport Handguard	Outer Barrel	Trigger Group	Hopup	Bolt	Magcatch	Piston Seal	Safety	Steel Magazine	Sport Magazine	Inner Barrel	BBs Tube	Trigger Rod	Stock	Buttplate	Cheekpad	Dustcover	Screws	O-Rings	
Aluminium 6000 series	■	■		■		■	■															
Aluminium ADC-12					■			■														
Steel CR1018 / SCM415					■		■	■	■	■	■											
Stainless steel SS304							■							■	■							
Steel 10.9																					■	
Brass													■									
Nylon PA6-GF15			■		■					■	■					■	■	■				
ABS												■										
Bakelite							■															
NBR 70°/80°							■										■		■			■
Silicon 60°						■																

# SIZE/MASS

Chassis / Barrel	Hand	Min. Mass	Min. Length
SRS-A2 16" Sport	right	2.240 kg	691 mm
SRS-A2 16" Covert	right	2.305 kg	708 mm
SRS-A2 22"	right	2.525 kg	865 mm
SRS-A2 16" Sport	left	2.240 kg	691 mm
SRS-A2 16" Covert	left	2.305 kg	708 mm
SRS-A2 22"	left	2.525 kg	865 mm

Magazine	Capacity	Soft Follower	Mass
Steel	30 rounds	compatible	0.195 kg
Aluminium	30 rounds	compatible	0.105 kg
Sport	25 rounds	not compatible	0.060 kg

Mass tolerances: +/- 0.005 kg. Size tolerances: +/- 1 mm. All mass measurements are made without the magazine and the stock extension (SRS-040002), but a 60 N spring inclusive.



SERIAL NUMBER:

Color:

black.....  
flat dark earth.....  
olive drab.....

Type:

16" Sport.....  
16" Covert.....  
22".....

Hand:

left handed.....

right handed.....

## NOTES:

Scan this QR code and download the digital version of this user manual. In case of user manual update, this link will provide you with the latest version. If you wish to contact us regarding your SRS-A2 or receive news about this product line, please contact us at [info@silverback-airsoft.com](mailto:info@silverback-airsoft.com) with your serial number as reference.





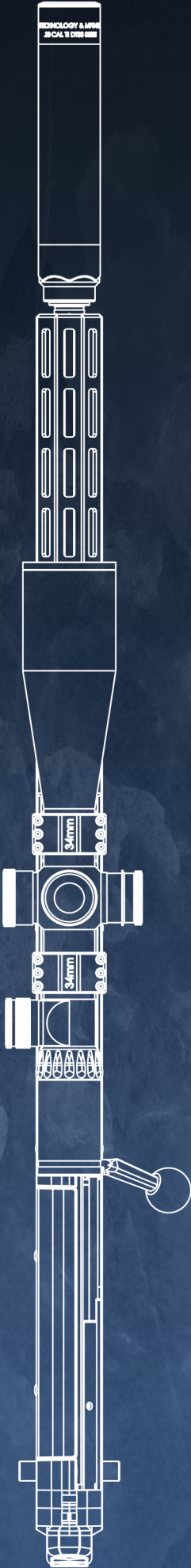
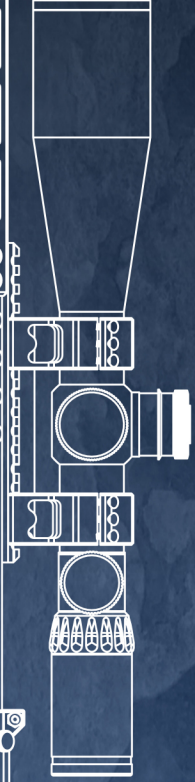
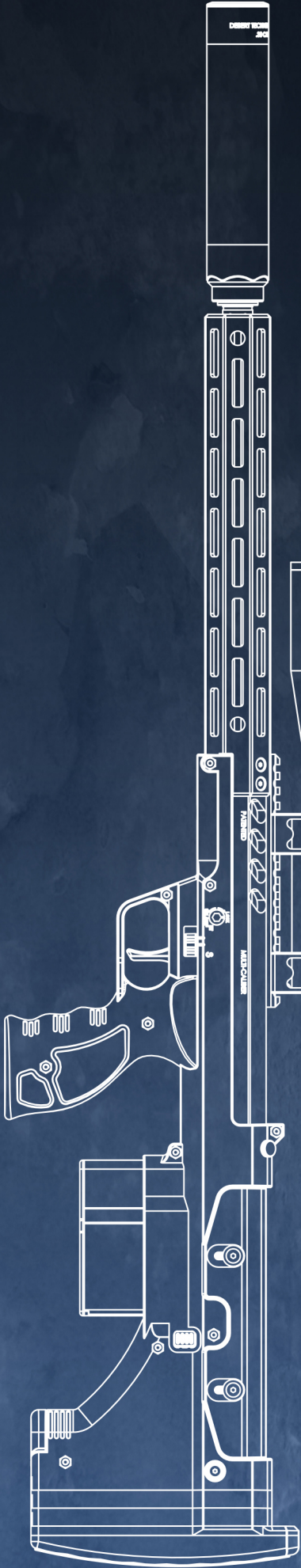





November 2020 - Made in Hong Kong

**SILVERBACK AIRSOFT**